



B TWIST CONCEALED

Door closers



SCOPE OF APPLICATION

- > Interior doors
- > Single or double-action doors

TECHNICAL DATA

- > 500.000 opening tested cam mechanism
- > Maximum door open angle 150°
- > 2 closing speed controllers
- > Force 3
- > Adjustable in 2 directions (+/- 3mm)

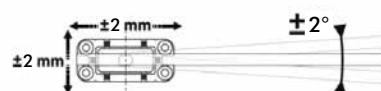
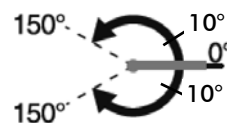

BENEFITS

- > Simple and quick installation
- > Non-excavating
- > Visually attractive

VARIANTS

> No hold open

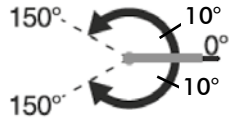

> Hold open 90°

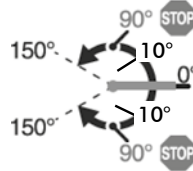

FINISHES

> Stainless steel

CONDITIONS OF USE

> Suitable doors:

Max. door weight	Door width	Glass thickness	Temperature of use
100 kg	950 mm	40 mm	10°C to 50°C

INSTALLATION

> Size:

	Length	Width	Height
Mechanism	181 mm	32 mm	56 mm
Socket	110 mm	48 mm	9 mm

Assembly instructions sheet included

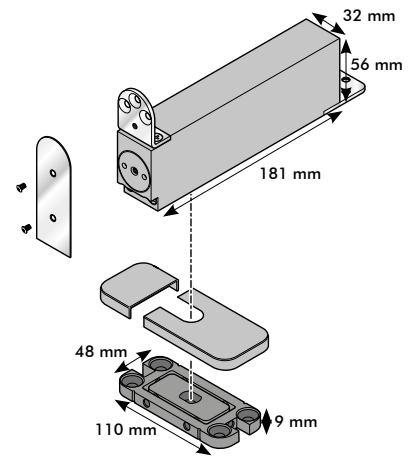

ACCESSORIES

> Adjustable hinge

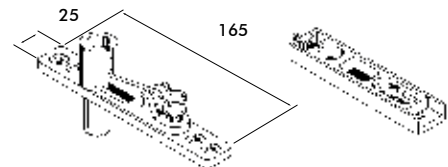

> Floor plate B-Twist

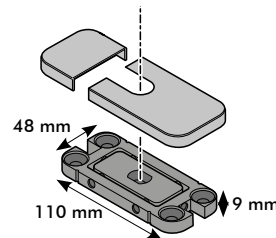

> T-Twist



REFERENCES

S3306024

Polish **ZD313505**
Satin **ZD313504**

SN314764

SAINT-GOBAIN
SEVA

SAINT-GOBAIN SEVA

43, rue du Pont de Fer
BP 10176
71105 Chalon-s-Saône Cedex
FRANCE

Tél. +33 (0)3 85 47 25 59
Fax +33 (0)3 85 47 25 38

This document is for information only and is not contractually binding.

www.sevax.com



* See Price list